

17C13A2E AutoScan Color Monitor

English	Operating Instructions	2 - 19
Français	Mode d'emploi	20 - 37

Appendix

English	Declaration FCC A1
	Information for Users in the U.S. A3
	Warranty/address	A5 ... A6
Deutsch	Hinweis/GS/ACHTUNG A4
Français	Declaration FCC A2

For Customer Use:

Enter below the Serial No. which is located on the back of the cabinet. Retain this information for future reference.

Model No. 17C13A2E

Serial No.



 This "bolt of lightning" indicates that uninsulated material within your unit may cause an electrical shock. For the safety of everyone, do not remove product covering.

 This "exclamation point" calls attention to a feature for which you should read the enclosed literature carefully to prevent operating and maintenance problems.

Introduction

The colour monitor displays sharp images of text and graphics with a maximum resolution up to 1280x1024 pixels. It is optimal for Windows, CAD / CAM / CAE, desktop publishing, spread sheets, multi-media, and any other application which demands large screen size and high resolutions.

This monitor automatically scans horizontal frequencies from 30KHz to 69KHz, and vertical frequencies from 50Hz to 120Hz. With microprocessor based digital controlled circuit, the monitor can automatically adjust itself to the video card's scanning frequency and displays an image with precise parameters you desire. The wide range of scanning frequency supports variety of operating platforms, such as IBM PC and compatibles.



Feature Highlights

- **On-Screen-Display** function provides more informations when the user operates the control functions. This feature provides user-friendliness and ease-of-use when operating the monitor.
 - **Anti-Glare** and **Anti-Static** screen coating eliminate any bad effects caused by the screen surface such as reflection of the room lights and dust attraction.
 - **Green Design** including automatic power saving function (NUTEK) and low emission MPRII compliance shows our commitment in environmental care.
 - **DDC1/DDC2B** allows communication between the monitor and PC system for optimal video configuration.
-

Note: If you experienced your monitor display is changing from color to mono, it's possible that you are using a non-VESA-DDC-standard video card. Please consult with your local PHILIPS dealer for more information.

As an Energy Star Partner, MAGNAVOX, has determined that this product meets the Energy Star guidelines for energy efficiency.

IBM, IBM PC and Power PC are registered trademarks of International Business Machines Corporation.

Safety precautions and maintenance

- ◆ Disconnect the monitor from the mains supply if the monitor is not to be used for an extended period of time.
- ◆ Do not attempt to remove the back cover, as you will be exposed to a shock hazard. The back cover should only be removed by qualified service personnel.
- ◆ Do not place objects on top of the monitor cabinet, which could fall into vents or which could cover them and prevent proper cooling of the monitor's electronic devices.
- ◆ Do not expose the monitor to rain or excessive moisture to avoid the risk of shock or permanent damage to the set.
- ◆ Do not use alcohol or ammonia based liquid to clean the monitor. If necessary, clean with a slightly damp cloth. Disconnect the monitor from the mains supply before cleaning.
- ◆ Consult a service technician if the monitor does not operate normally when operating instructions of this manual are followed.

Package

Your package includes the following items:

- The monitor (integrated with tilt / swivel pedestal)
- Power cord
- Interface cable (flying-in)
- MAC adapter

End of life disposal

Your new set contains materials which can be recycled and reused. Specialized companies can recycle your product to increase the amount of reusable materials and to minimize the amount of materials to be disposed of.

Please inform yourself on local regulations on disposal of your old set.

Installation

Important: Please refer to the user's manuals of your computer and video adapter to make sure these equipments are properly installed and configured before installing the monitor.

Positioning / Ventilation

- ◆ Avoid exposing the monitor to direct sunlight, stoves or any other heat sources.
- ◆ To prevent overheating, make sure that the ventilation openings of the monitor are not covered.
- ◆ Keep moisture and dust away.
- ◆ Keep away from any magnetic objects, such as speakers, electric motors, transformers, ...etc.
- ◆ When positioning this monitor, make sure that the mains plug and socket are easily accessible.

Pedestal

With the built-in pedestal you can tilt and / or swivel the monitor for a most comfortable viewing angle.

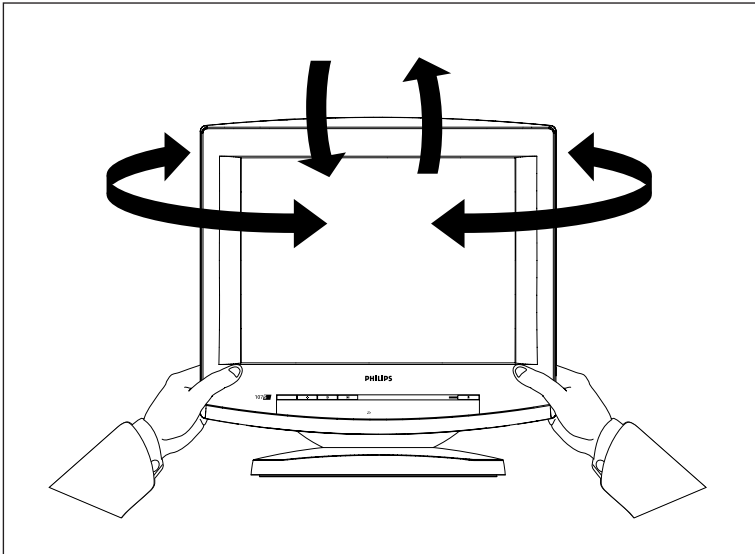

Connection

Important: Please make sure the AC power to your computer is "OFF" before connecting or disconnecting any display peripheral. Failure to do so may cause serious personal injury as well as permanent damage to your computer equipments.

- Connect the monitor to the computer using the supplied interface cables. Connection with computer system other than IBM PC or Apple computers may need different type of adapters. Please consult your computer supplier for these adapters. Connect the power cord to a wall outlet after the interface cable is properly connected.

Monitor rear view

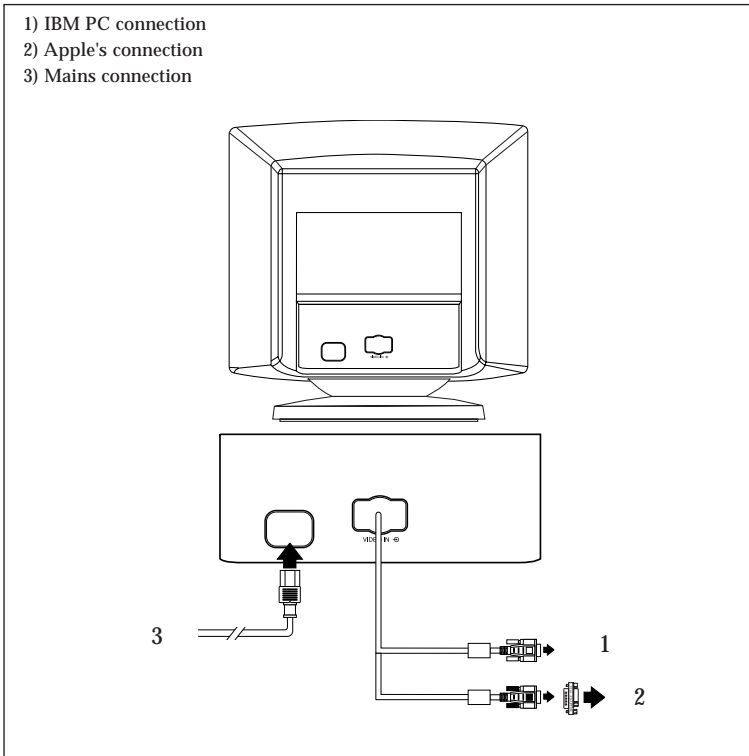

Control locations and functions

Monitor control panel

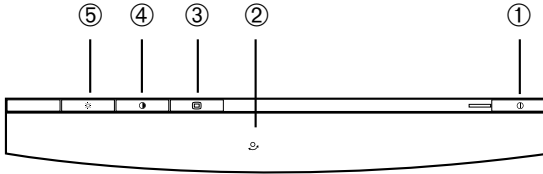

Descriptions of knobs and keypads on front control panel

- ① • Press this knob to switch ON and OFF of monitor's power.
- ② • OSD rotary control knob.
- ③ • Active OSD menu.
- ④ • Adjust contrast of the display.
- ⑤ • Adjust brightness of the display.

OSD menu tree structure

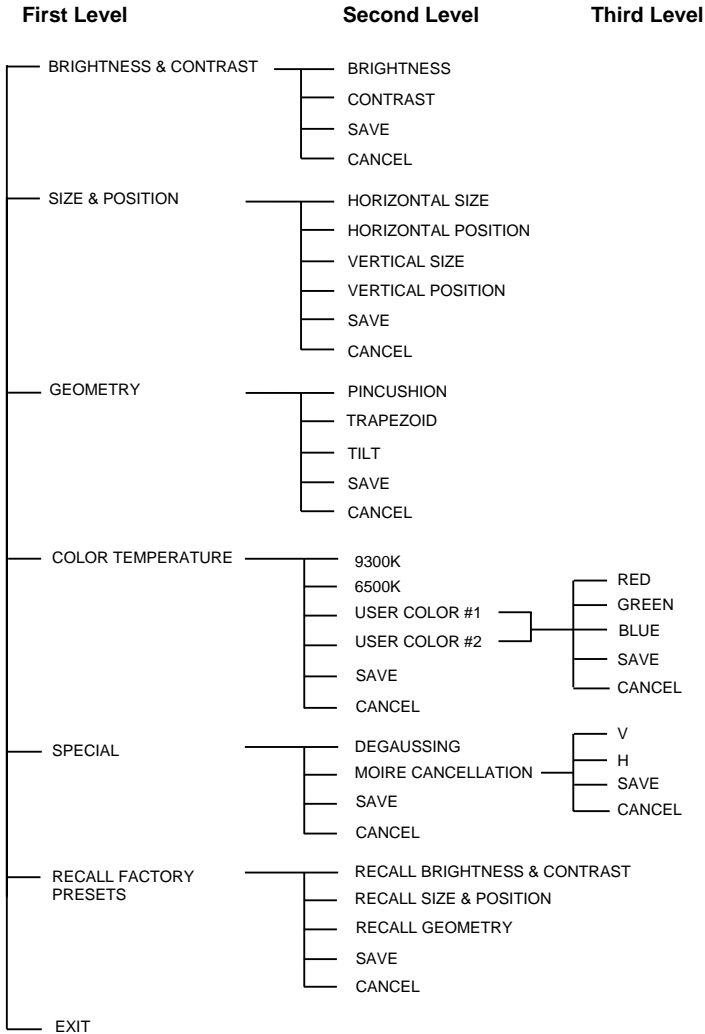





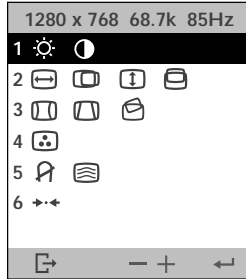

On-Screen-Display

Activating the On-Screen-Display

The monitor controls are accessed by pressing button  to enable OSD (On-Screen-Display). The main menu will be displayed as follows.



Each Sub-Menu (1-6) is selected by highlighting it via the rotary control , and pressing button  to confirm. To exit OSD, highlight  at the bottom of the main menu and press select button .

While operating Sub-Menu, please use rotary control , to select or adjust and press button  to confirm.

Note: If adjustment or selection of any OSD menu is not made for more than 20 seconds, the current setup will be saved and the OSD will disappear automatically.

Sub Menu-1: BRIGHTNESS & CONTRAST

-  Brightness : Adjusts background brightness

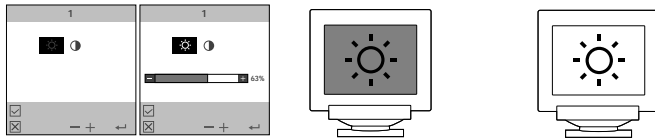

-  Contrast : Adjusts contrast between foreground and background.

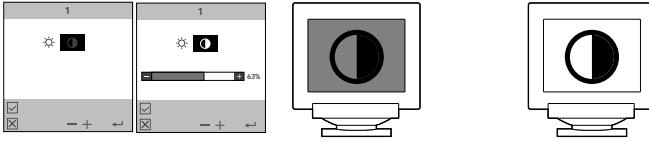

- Save : Save user adjustment and return to main menu.
- Cancel : Abandon setup and return to main menu.

Sub Menu-2: SIZE & POSITION

-  Horizontal Size : Adjusts image width

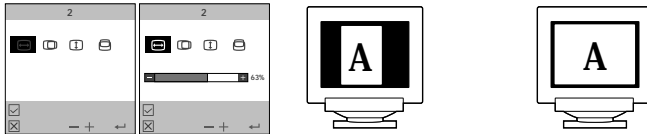

-  Horizontal Position : Moves image left or right



-  Vertical Size : Adjusts image height

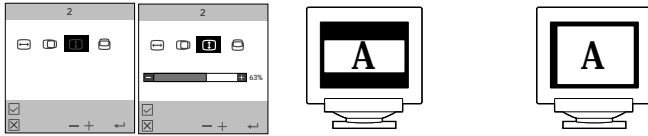

-  Vertical Position : Moves image up or down

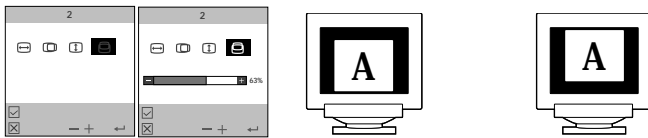

- Save : Save user adjustment and return to main menu.
- Cancel : Abandon setup and return to main menu.

Sub Menu-3: GEOMETRY

-  Pincushion : Adjusts the amount of curvature on the vertical edges.

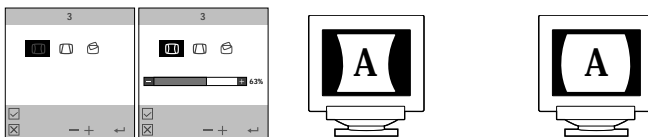

-  Trapezoid : Equalizes the length of the top and bottom edges.

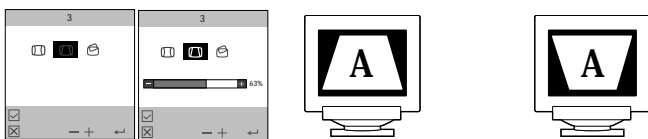

-  Tilt : Tilts the image clockwise or counter-clockwise.

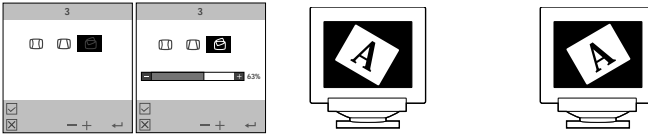

- Save : Save user adjustment and return to main menu.
- Cancel : Abandon setup and return to main menu.

Sub Menu-4: COLOR TEMPERATURE

- 9300°K : Factory preset color temperature of 9300°K.

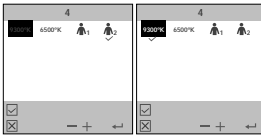

- 6500°K : Factory preset color temperature of 6500°K.



-  User 1 : User set 1 for color temperature then select R, G or B for adjustment.
 - R : Adjusts red intensity.
 - G : Adjusts green intensity.
 - B : Adjusts blue intensity.



-  User 2 : User set 2 for color temperature then select R, G or B for adjustment.
 - R : Adjusts red intensity.
 - G : Adjusts green intensity.
 - B : Adjusts blue intensity.



- Save : Save user adjustment and return to main menu.
- Cancel : Abandon setup and return to main menu.

Sub Menu-5: SPECIAL

-  Manual Degauss : Discoloration of the image can be caused by gradual magnetization of the monitor components. This is particularly likely to occur when the monitor is moved or rotated. The monitor may "buzz" momentarily when the user control is selected and the image will change color and wobble for a few seconds. These effects are normal.

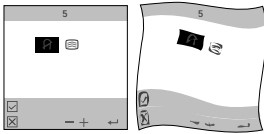

-  Moire Cancellation : Moire effect may be found in some display modes. If this is the case, please use "Moire Cancellation" function to reduce Moire effect.

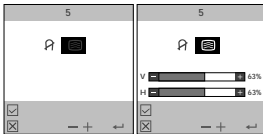

- Save : Save user adjustment and return to main menu.
- Cancel : Abandon setup and return to main menu.

Sub Menu-6: RECALL FACTORY PRESETS

- ☀️ 🕒 Recall : Recall brightness and contrast presets.

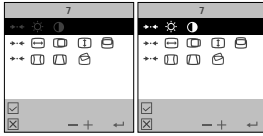

- 📏 📐 📏 📏 Recall : Recall size and phase presets.

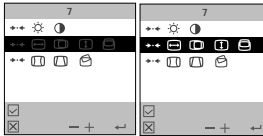

- 📏 📏 📏 Recall : Recall geometry preset.

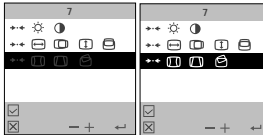

- Save : Save user adjustment and return to main menu.
- Cancel : Abandon setup and return to main menu.

* Whenever the signal cable is disconnected, the screen will appear a message as below:



Data Storage

(A) Factory preset mode:

This monitor has 11 factory-preset modes as indicated in the following table:

	Mode	Resolution	Frequency		Sync polarity	
			H(KHz)	V(Hz)	H	V
M01	VGA	640x400	31.5	70	-	+
M02	VGA	640x480	31.5	60	-	-
M03	VGA	640x480	37.5	75	-	-
M04	VESA	640x480	43.3	85	-	-
M05	SVGA	800x600	37.8	60	+	+
M06	SVGA	800x600	46.9	75	+	+
M07	VESA	800x600	53.7	85	+	+
M08	VESA	1024x768	48.4	60	-	-
M09	VESA	1024x768	60.0	75	+	+
M10	VESA	1024x768	68.7	85	+	+
M11	VESA	1280x1024	64.0	60	+	+

* Does not support sync-on-green.

(B) User mode

In addition to factory preset modes, the monitor can also provides additional 11 User-defined modes.

If the input video signal is different from our factory-preset modes, the new timing data will be automatically stored. However, the displayed parameters may need to be adjusted. User can adjust the parameters via OSD, as preceding procedures which already described on "Adjustment via On-Screen-Display" section.

(C) New mode

The monitor is reversed for 4 new modes in case non-standard video modes are used.

Automatic Power Saving

If you have VESA's DPMS compliance display card or software installed in your PC, the monitor can automatically reduce its power consumption when not in use. And if an input from keyboard, mouse or other input devices is detected, the monitor will automatically "wake up". The following table shows the power consumption and signalling of this automatic power saving feature:

Power Management Definition						
VESA's mode	Video	H-sync	V-sync	Power used	Power saving(%)	LED color
ON	Active	Yes	Yes	< 100W	0%	Green
Stand-by	Blanked	No	Yes	< 15W	85%	Yellow
Suspend	Blanked	Yes	No	< 15W	85%	Yellow
OFF	Blanked	No	No	< 8W	92%	Amber

This monitor is Energy Star compliant and TCO'92 power management compatible.



AS AN ENERGY STAR PARTNER, MAGNAVOX, HAS DETERMINED THAT THIS PRODUCT MEETS THE ENERGY STAR GUIDELINES FOR ENERGY EFFICIENCY.

Specification*

(I) General

CRT

Screen size	: 17" (43.2 cm) flat & square
Dot pitch	: 0.28 mm
Phosphor	: P22 or equivalent, medium short persistence
Screen treatment	: Anti-glare, anti-static

Display area

Factory preset	: 306 mm (H) x 230 mm (V)
Maximum usable	: 323 mm (H) x 242 mm (V)

Scanning frequency

Horizontal (line)	: 30-69 kHz (AutoScan)
Vertical (frame)	: 50-120 Hz (AutoScan)

Input power

: 100-240 VAC, 50-60 Hz

Power consumption

: 100 Watt normal, 110 Watt maximum

Input signal

Video	: 0.7 Vpp, 75 Ohm impedance
Sync	: Separate sync. TTL level Composite sync. TTL level

Pedestal

Tilt	: 5° forward, 13° backward
Swivel	: 90° leftward, 90° rightward

Physical

Unit dimension (WxHxD)	: 420 x 424 x 452 (mm)
Net weight	: 18.5 kg

Operating condition

Temperature	: 0° C - 40° C
Humidity	: 20% - 80%

Storage condition

Temperature	: -25° C - 70° C
Humidity	: 10% - 95%

White Color Coordinates:

Red:	x= 0.625	Blue:	x= 0.150
	y= 0.340		y= 0.065
Green:	x= 0.285		
	y= 0.605		

* Because of a policy of continuous product improvement, the above specifications are subjected to change without notice.

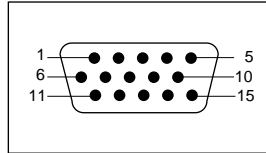
(II) Pin assignment:

The 15-pin D-sub connector (male) of the signal cable (IBM systems):

Pin No.	Assignment	Pin No.	Assignment
1	Red video input	9	No pin
2	Green video input	10	Self-test
3	Blue video input	11	Ground
4	Ground	12	Serial data line (SDA)
5	Identical output - Connected to pin 10	13	H. Sync / H+V
6	Red video ground	14	V. Sync (VCLK for DDC)
7	Green video ground	15	Data clock line (SDA)
8	Blue video ground		